

N200A-SR

Wi-Fi Single-band 1x1 802.11b/g/n/ac/ax

+ Bluetooth 5.0

Combo Module Datasheet



N200A-SR Module Datasheet

Factory: No.8, Litong Road, Liuyang Economic & Technical
Development Zone, Changsha, Hunan, CHINA
TEL: +86-755-2955-8186
Website: www.fn-link.com

Customer Approval : _____ Company

Title

Signature

Date

Fn-Link

Revision History

Version	Date	Revision Content	Draft	Approved
1.0	2021/05/27	Draft version	Lgp	Szs
2.0	2021/05/29	Update pin22 definition; Update reference design	Lgp	Szs
3.0	2021/06/10	Update block diagram; Update pin definition; Update RF specification	Lgp	Qjp
4.0	2021/06/16	Delete host interface timing diagram chapter	Lgp	Qjp
4.1	2021/09/01	Update TX power spec	LXY	QJP
4.2	2021/10/13	Added mcs10/11 mode description	LXY	QJP
4.3	2021/11/22	Added -01 type model	LXY	QJP

CONTENTS

1 Overview.....	1
1.1 Introduction.....	1
1.2 Features.....	1
1.3 General Specification.....	2
1.4 Recommended Operating Rating.....	2
1.5 Power Consumption.....	2
※1.6 EEPROM Information.....	3
2 Wi-Fi RF Specification.....	3
2.1 2.4GHz RF Specification.....	3
3 Bluetooth Specification.....	5
3.1 Bluetooth Specification.....	5
4 Pin Assignments.....	6
4.1 Pin Outline.....	6
4.2 Pin Definition.....	6
5 Dimensions.....	8
5.1 Module Picture.....	8
5.2 Module Physical Dimensions.....	9
5.3 Layout Recommendation.....	10
6 Reference Design.....	11
7 Ordering Information.....	12
8 The Key Material List.....	12
9 Recommended Reflow Profile.....	13
10 Package Information.....	14
10.1 Reel.....	14
10.2 Carrier Tape Detail.....	14
10.3 Packaging Detail.....	15
10.4 Moisture sensitivity.....	16

1 Overview

1.1 Introduction

FN-Link Technology would like to announce a low-cost and low-power consumption module which has the Wi-Fi 6 (2.4G 802.11b/g/n/ac/ax) and Bluetooth 5.0 functionalities. Its WLAN function supports the USB 2.0 / SDIO 2.0 interface, and its BT function supports the UART/PCM interface. The module provides simple legacy and 20MHz/40MHz co-existence mechanism to ensure backward and network compatibility. The units, such as power management, PA (power amplifier) and LNA (low-noise amplifier) are integrated in the main chip of the module. The wireless module complies with IEEE 802.11 b/g/n/ac/ax standard and the PHY rate can achieve up to 229Mbps. This combo module is a total solution for a combination of Wi-Fi and Bluetooth V5.0 technologies. The module is specifically developed for all portable devices.

1.2 Features

- Compliant with IEEE 802.11b/g/n/ac/ax
- Up to 229Mbps PHY rate using 40MHz bandwidth
- Wi-Fi Security WEP / WPA / WPA2/WPA3-SAE Personal, MFP
- Support STA, SoftAP, Wi-Fi Direct modes concurrently
- Support STBC, beamforming
- Support Wi-Fi 6 TWT
- Support USB2.0, SDIO 2.0, UART, PCM
- Supports WLAN-Bluetooth coexistence

Block Diagram:

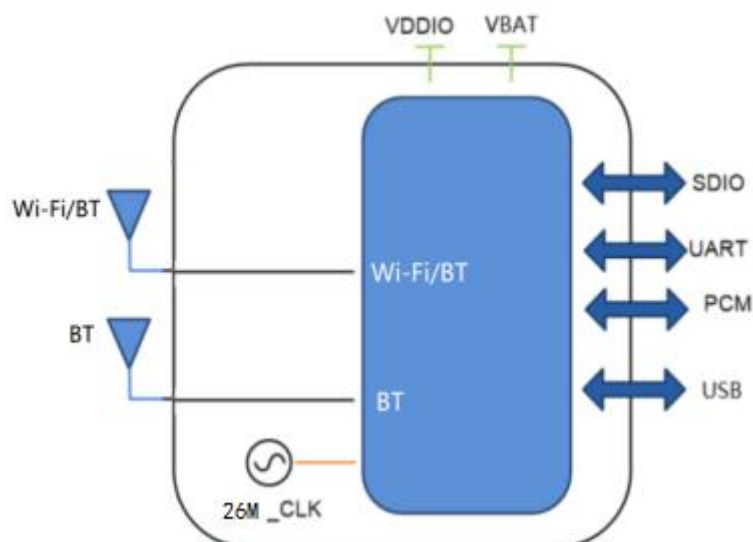

1.3 General Specification

Model Name	N200A-SR
Product Description	Support Wi-Fi functionalities
Dimension	L x W x T: 12 x 12 x 2.2 mm
Wi-Fi Interface	Support SDIO2.0 or USB2.0
Operating temperature	-20°C to 80°C
Storage temperature	-40°C to 85°C
RoHS	All hardware components are fully compliant with EU RoHS directive

1.4 Recommended Operating Rating

	Min.	Typ.	Max.	Unit
Operating Temperature	-20	25	80	deg.C
VBAT	3	3.3	3.8	V
VDDIO	1.7	3.3	3.6	V

1.5 Power Consumption

	Test condition: VBAT=3.3V VDDIO=3.3V	
	Current @ TX	Current @ RX
	Maximum(mA)	Maximum(mA)
11b@20dbm	239	39.5
11g@14dbm	157	39.2
HT20-mcs7@14dbm	158.1	39.3
HT40-mcs7@14dbm	145.8	39.6
VHT20-mcs8@14dbm	153.4	39.3
VHT40-mcs9@14dbm	143.1	39.6
HE20-mcs9@14dbm	149.9	39.2
HE40-mcs9@14dbm	139.9	39.7
HE20-mcs11@14dbm	148.8	/
HE40-mcs11@14dbm	139.9	/
BT	31.8	39

※1.6 EEPROM Information

WI-FI

Vendor ID	TBD
Product ID	TBD

2 Wi-Fi RF Specification

2.1 2.4GHz RF Specification

Feature	Description
WLAN Standard	IEEE 802.11b/g/n/ac/ax, Wi-Fi compliant
Frequency Range	2.400 GHz ~ 2.4835 GHz (2.4 GHz ISM Band)
Number of Channels	2.4GHz : Ch1 ~ Ch13,Ch14
Modulation	DBPSK/DQPSK/CCK(DSSS)、BPSK/QPSK/16QAM/64QAM(OFDM)
Spectrum Mask	Meet with IEEE standard
Freq. Tolerance	± 20ppm
Output Power	802.11b /11M : 20 ± 2 dBm @ EVM ≤ -9dB
	802.11g /54M : 14 ± 2 dBm @ EVM ≤ -25dB
	802.11n /MCS7 : 14 ± 2 dBm @ EVM ≤ -28dB
	802.11ac /MCS9 : 14 ± 2 dBm @ EVM ≤ -32dB
	802.11ax /MCS9 : 14 ± 2 dBm @ EVM ≤ -32dB
	802.11ax /MCS11 : 14 ± 2 dBm @ EVM ≤ -35dB
	Tx power control by driver userconfig file. recommended power index setting as below: [0] =8 (ofdm1lowrate) [1] =8 (ofdm64qam) [2] =8 (ofdm256qam) [3] =8 (ofdm1024qam) [4] =9 (dsss) //建议改 level8 功率 18dbm 符合 CE 认证标准. MCS10,MCS11 仅支持 TX 不支持 RX,模组协商模式最高支持 MCS9.

RX sensitivity		
Test Items	Typical Value	Standard Value
Receive Sensitivity (11b) @8% PER	- 11Mbps ≤-85dBm	≤-76dBm
Receive Sensitivity (11g) @10% PER	- 54Mbps ≤-73dBm	≤-68dBm
Receive Sensitivity (11n,20MHz) @10% PER	- MCS=7 ≤-70dBm	≤-67dBm
Receive Sensitivity (11n,40MHz) @10% PER	- MCS=7 ≤-68dBm	≤-64dBm
Receive Sensitivity (11ac,20MHz) @10% PER	- MCS=8 ≤-67dBm	≤-59dBm
Receive Sensitivity (11ac,40MHz) @10% PER	- MCS=9 ≤-63dBm	≤-54dBm
Receive Sensitivity (11ax,20MHz) @10% PER	- MCS=9 ≤-65dBm	≤-57dBm
Receive Sensitivity (11ax,40MHz) @10% PER	- MCS=9 ≤-62dBm	≤-54dBm
Maximum Input Level	802.11b: -10 dBm	
	802.11g/n: -20 dBm	
Antenna Reference	Small antennas with 0~2 dBi peak gain	

3 Bluetooth Specification

3.1 Bluetooth Specification

Feature	Description		
General Specification			
Bluetooth Standard	Bluetooth V5.0		
Host Interface	UART/PCM*		
Antenna Reference	Small antennas with 0~2 dBi peak gain		
Frequency Band	2402 MHz ~ 2480 MHz		
Number of Channels	79 channels		
Modulation	GFSK, $\pi/4$ -DQPSK, 8DPSK		
RF Specification			
	Min.	Typical.	Max.
Output Power (BT only)	-3dBm	5dBm	8dBm
Output Power (combo)	5dBm	13dBm	16dBm
Sensitivity @ BER=0.1% for GFSK (1Mbps)			-70 dBm
Sensitivity @ BER=0.01% for $\pi/4$ -DQPSK (2Mbps)			-70 dBm
Sensitivity @ BER=0.01% for 8DPSK (3Mbps)			-70 dBm
Maximum Input Level	GFSK (1Mbps): -20dBm		
	$\pi/4$ -DQPSK (2Mbps): -20dBm		
	8DPSK (3Mbps): -20dBm		

Note:

- 1, The PCM voltage level is 3.3V;
- 2, The module support VoHCI on UART1.

4 Pin Assignments

4.1 Pin Outline

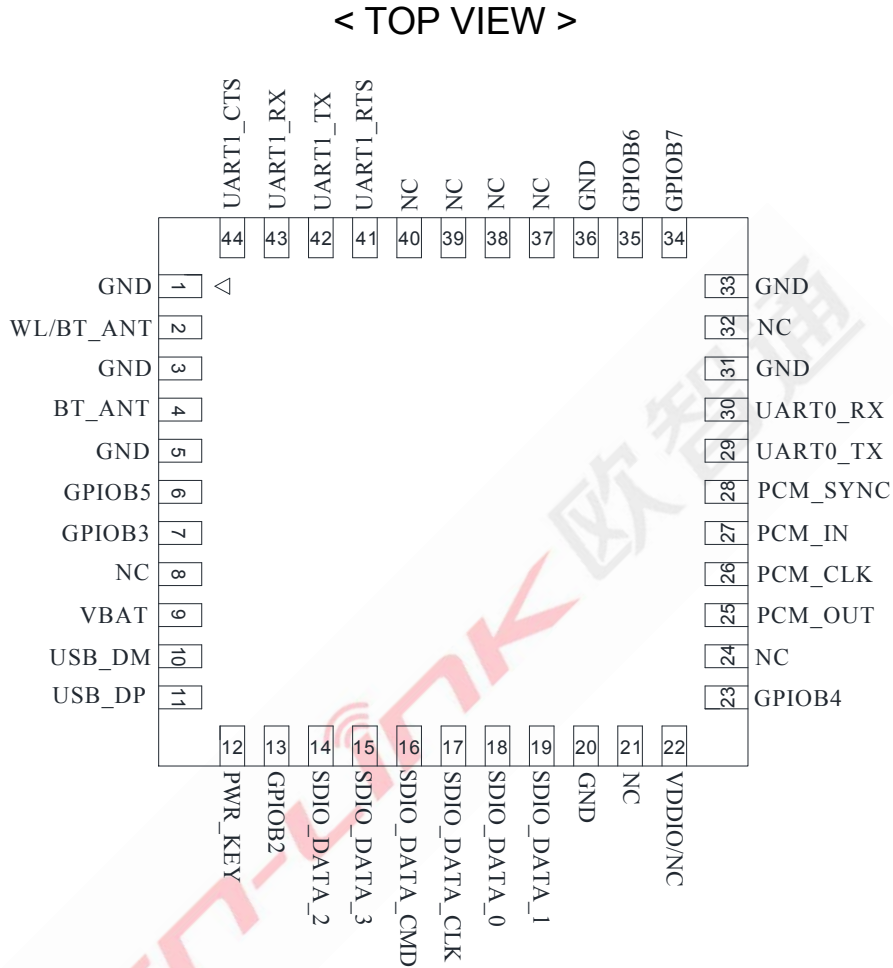

4.2 Pin Definition

NO	Name	Type	Description	Voltage
1	GND	—	Ground connections	
2	WL/BT_ANT	I/O	WLAN and BT RF I/O port	
3	GND	—	Ground connections	
4	BT_ANT	I/O	BT only I/O port (single ant version NC this pin)	
5	GND	—	Ground connections	
6	GPIOB5	I/O	GPIOB5	VDDIO

7	GPIOB3	I/O	GPIOB3	VDDIO
8	NC	—	Floating (Don't connected to ground)	
9	VBAT	P	Main power voltage source input	VBAT
10	USB_DM	I/O	USB 2.0 differential signal	
11	USB_DP	I/O		
12	PWR_KEY	I	Power Enable: pull high» 6ms Power Disable: pull low	VDDIO
13	GPIOB2	I/O	GPIOB2	VDDIO
14	SD_D2	I/O	SDIO data line 2	VDDIO
15	SD_D3	I/O	SDIO data line 3	VDDIO
16	SD_CMD	I/O	SDIO command line	VDDIO
17	SD_CLK	I/O	SDIO clock line	VDDIO
18	SD_D0	I/O	SDIO data line 0	VDDIO
19	SD_D1	I/O	SDIO data line 1	VDDIO
20	GND	—	Ground connections	
21	NC	—	Floating (Don't connected to ground)	
22	VDDIO	P	I/O Voltage supply input	VDDIO
23	GPIOB4	I/O	GPIOB4	
24	NC	—	Floating (Don't connected to ground)	
25	PCM_OUT	O	PCM data output	3.3V
26	PCM_CLK	I/O	PCM clock	
27	PCM_IN	I	PCM data input	
28	PCM_SYNC	O	PCM synchronization control	
29	UART0_TX	O	UART0_TX, for test and download	VDDIO
30	UART0_RX	I	UART0_RX, for test and download	VDDIO
31	GND	—	Ground connections	
32	NC	—	Floating (Don't connected to ground)	
33	GND	—	Ground connections	
34	GPIOB7	I/O	GPIOB7	VDDIO
35	GPIOB6	I/O	GPIOB6	
36	GND	—	Ground connections	
37	NC	—	Floating (Don't connected to ground)	
38	NC	—	Floating (Don't connected to ground)	
39	NC	—	Floating (Don't connected to ground)	
40	NC	—	Floating (Don't connected to ground)	
41	UART1_RTS	O	UART1 request to send	VDDIO



42	UART1_TX	O	UART1 TX	VDDIO
43	UART1_RX	I	UART1 RX	VDDIO
44	UART1_CTS	I	UART1 clear to send	VDDIO

P:POWER I:INPUT O:OUTPUT

5 Dimensions

5.1 Module Picture

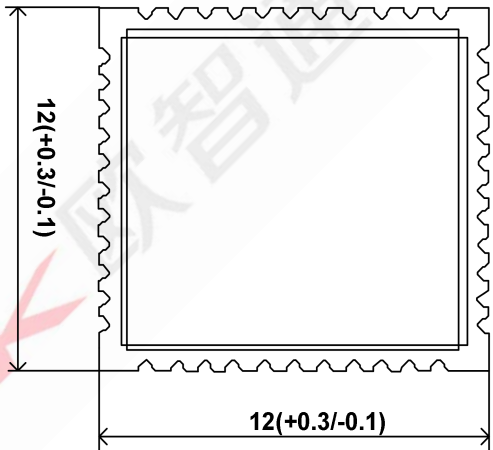
(Unit: mm)

<p>L x W : 12 x 12 (+0.3/-0.1) mm</p> 	
<p>H: 2.2 (±0.2) mm</p>	
<p>Weight</p>	<p>0.5 g</p>

Note:

Module picture will be updated in future version.

5.2 Module Physical Dimensions

(Unit: mm)

< TOP VIEW >

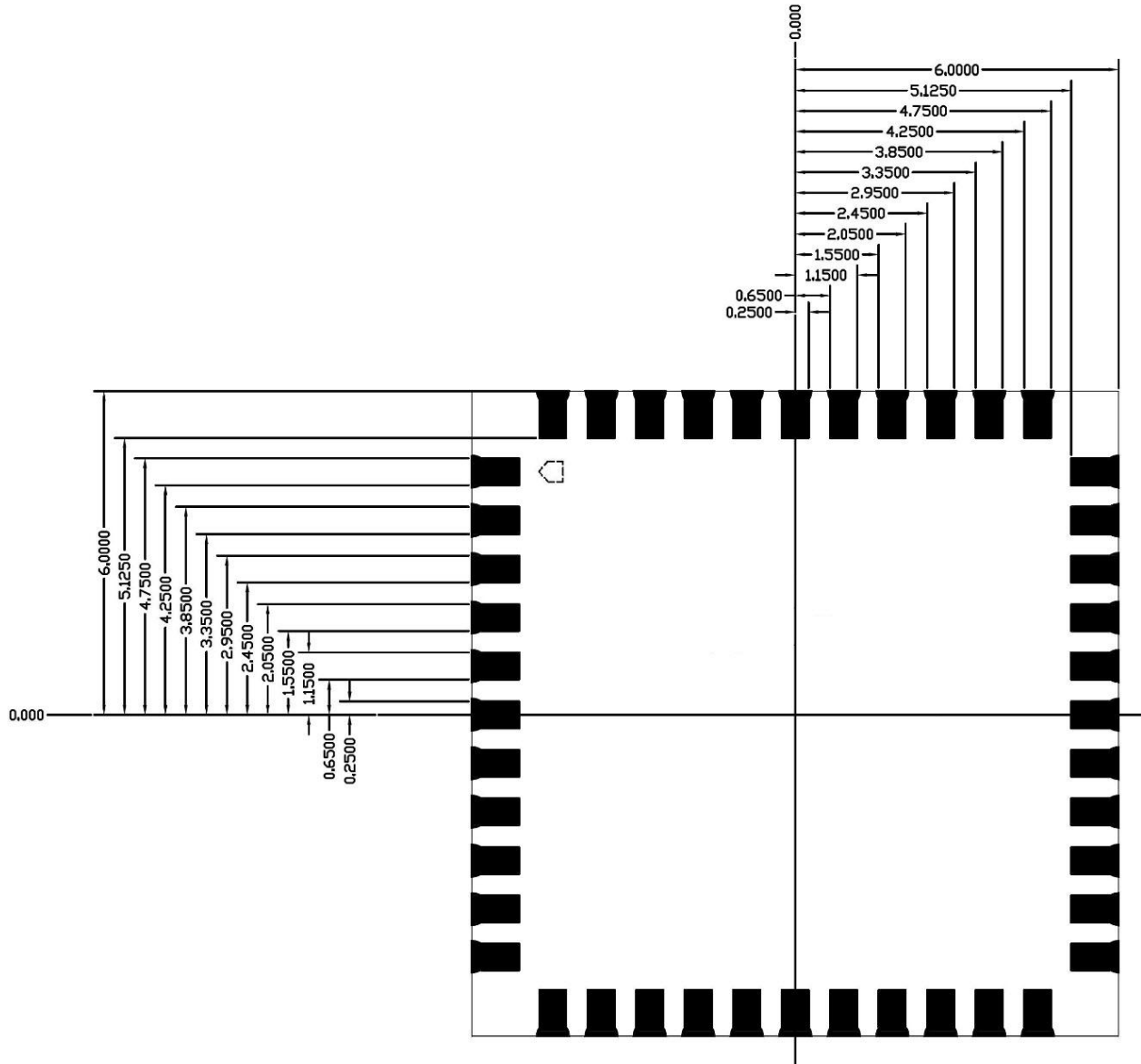

5.3 Layout Recommendation

(Unit: mm)

< TOP VIEW >

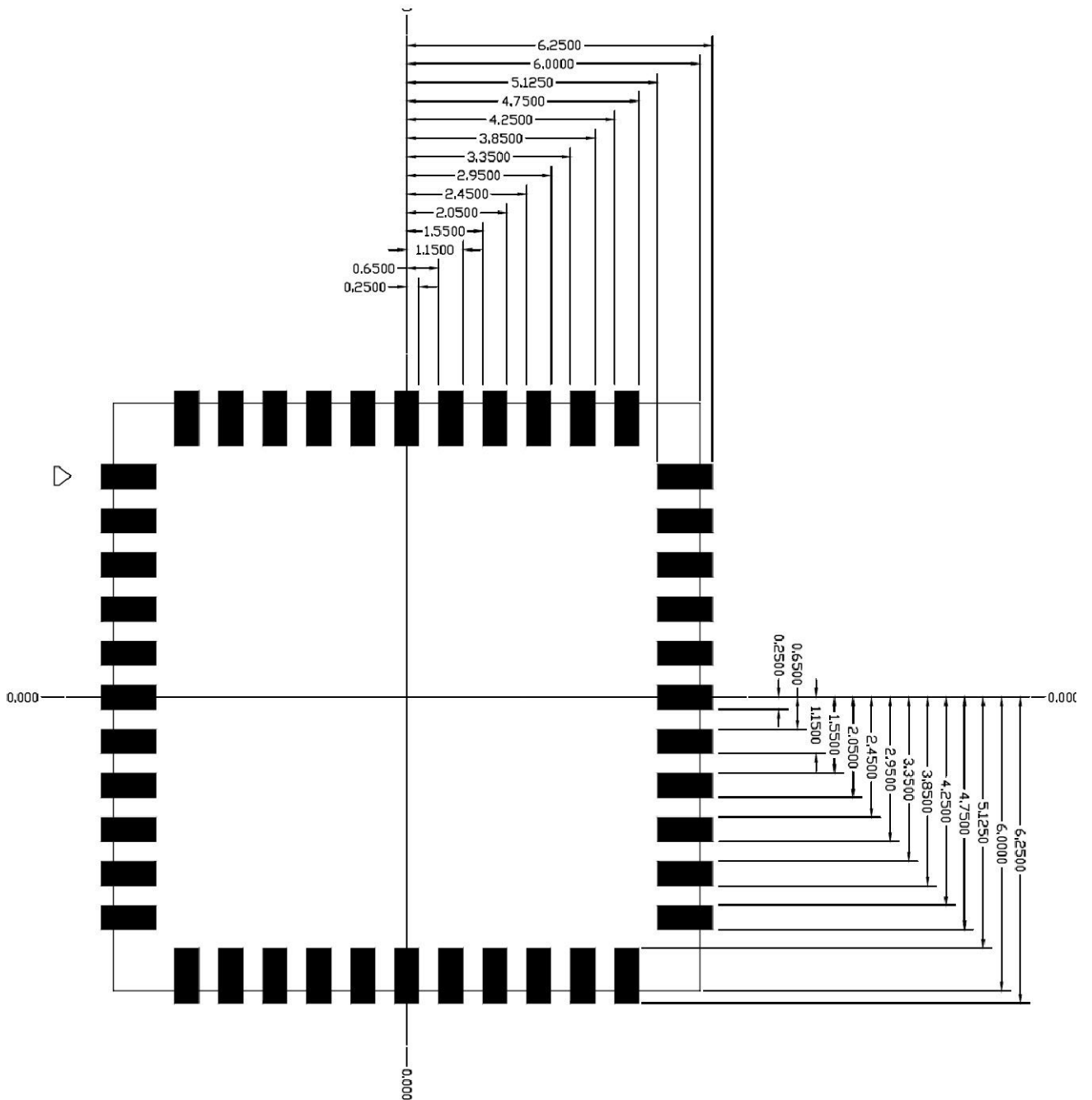

6 Reference Design

Note: Module requires independent power supply , supply capacity $\geq 350\text{mA}$ and ripple less than 100mV; Do not share power with amplifier, infrared device, camera, etc.

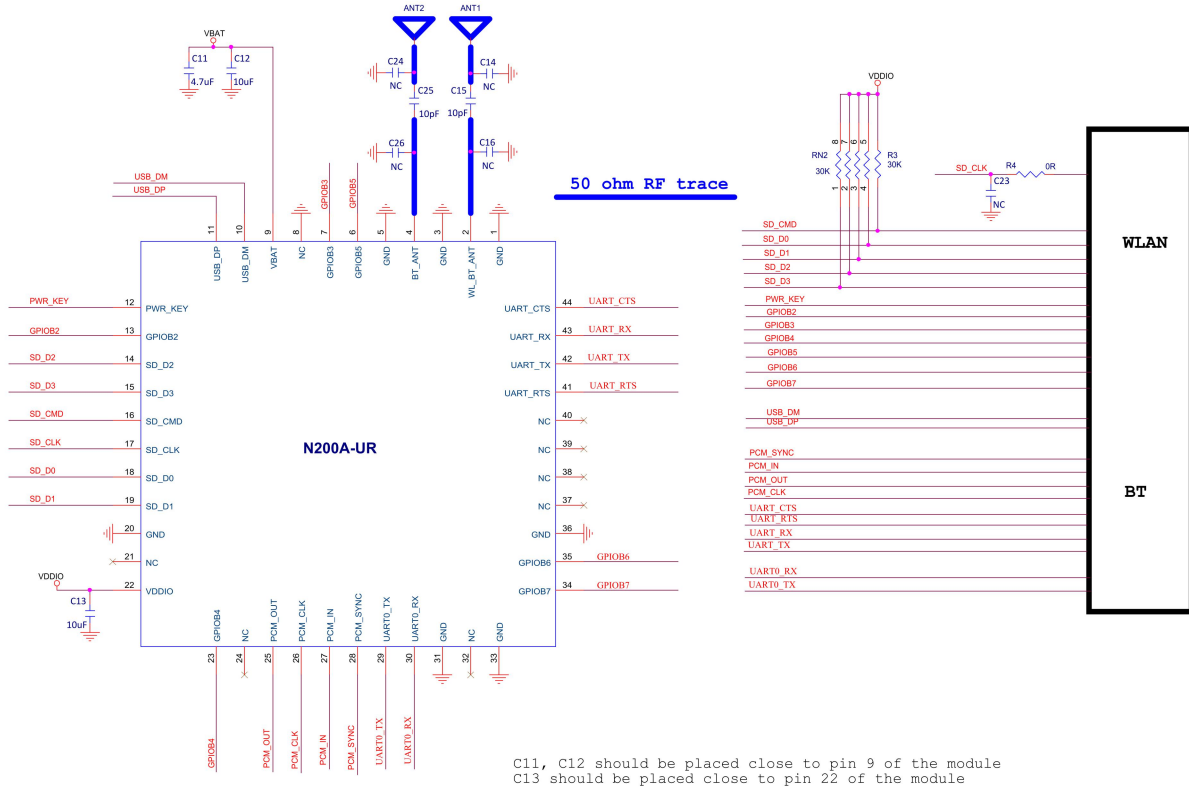

7 Ordering Information

Part No.	Description
FGN200ASRX-00	AIC8800M, b/g/n/ac/ax Wi-Fi,BT5.0, 1T1R, 12x12mm, USB, SDIO, UART, PCM 双天线版,(HK)
FGN200ASRX-01	AIC8800M, b/g/n/ac/ax Wi-Fi,BT5.0, 1T1R, 12x12mm, USB, SDIO, UART, PCM 双天线版,(ESD)

8 The Key Material List

Item	Part Name	Description	Manufacturer
1	Inductor	1608 4.7uH, ±20%	Sunlord,Ceaiya,Cenker, Taiyo
2	Crystal	3225 26MHz ±10ppm	ECEC, TKD, Hosonic, JWT, TXC
3	Chipset	AIC8800M	AIC
4	PCB	FR4, 4 LAYER, GREEN	XY-PCB, GDKX, Sunlord, SLPCB
5	shielding	N200A-SR shielding	Sun-tek,JLitong
6	TVS	0201,5V, 0.15pF,12KV	WAYON,Murata

9 Recommended Reflow Profile

Referred to IPC/JEDEC standard.

Peak Temperature : $\leq 260^{\circ}\text{C}$

Number of Times : ≤ 2 times

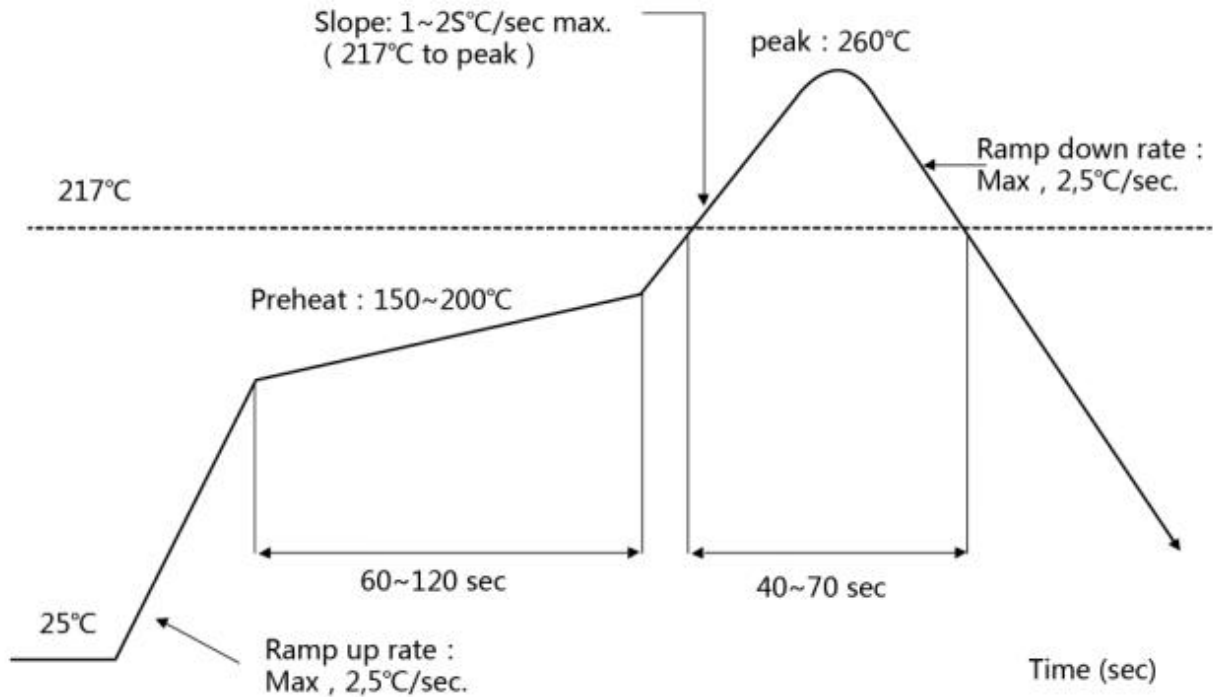

10 Package Information

10.1 Reel

A roll of 1500pcs

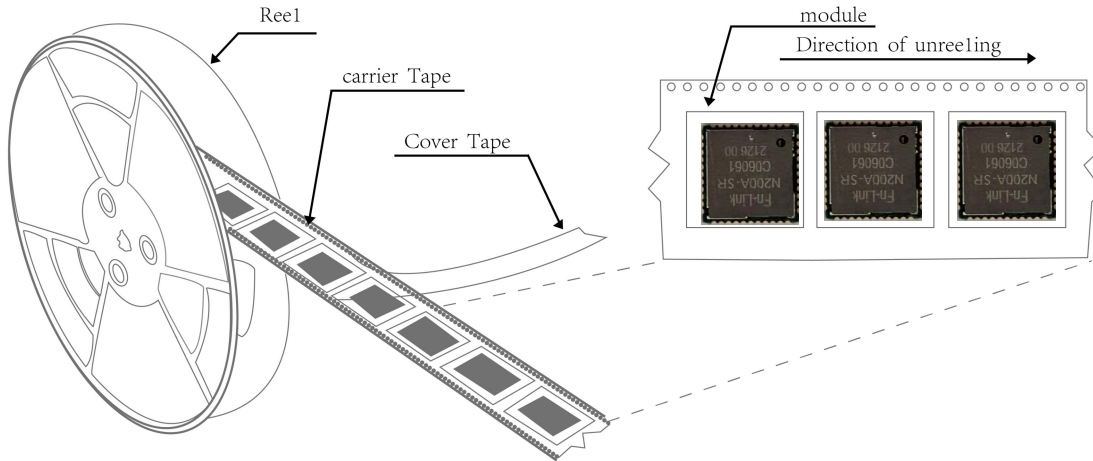

10.2 Carrier Tape Detail

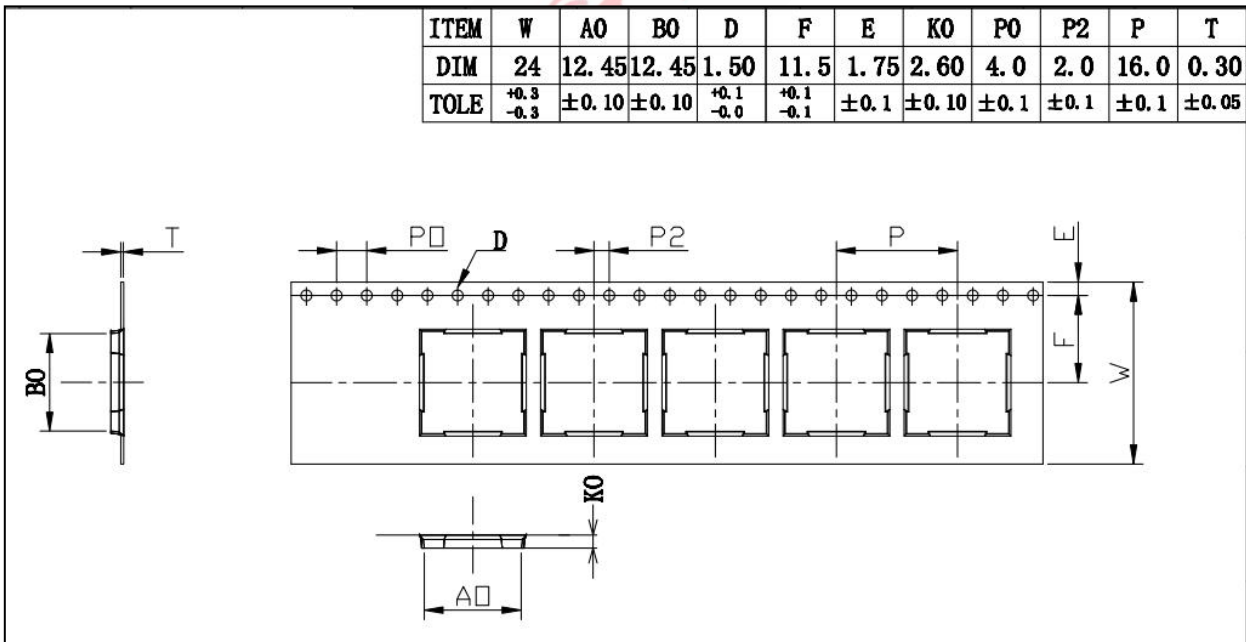

10.3 Packaging Detail

the take-up package



Using self-adhesive tape

Size of black tape:24mm*32.6m the cover tape :21.3mm*32.6m

Color of plastic disc:blue



NY bag size:460mm*385mm



size : 350*350*35mm



The packing case size:350*210*370mm

10.4 Moisture sensitivity

The Modules is a Moisture Sensitive Device level 3, in according with standard IPC/JEDEC J-STD-020, take care

all the relatives requirements for using this kind of components.

Moreover, the customer has to take care of the following conditions:

- a) Calculated shelf life in sealed bag: 12 months at <math><40^{\circ}\text{C}</math> and <math><90\%</math> relative humidity(RH).
- b) Environmental condition during the production: - c) The maximum time between the opening of the sealed bag and the reflow process must be 168 hours if condition
- b) "IPC/JEDEC J-STD-033A paragraph 5.2" is respected
- d) Baking is required if conditions b) or c) are not respected
- e) Baking is required if the humidity indicator inside the bag indicates 10% RH or more